



## ELECTRICAL WHEEL BARROW

FBRE40V  
FBRE40V-UK



ORIGINAL INSTRUCTIONS



PLEASE READ THIS MANUAL CAREFULLY BEFORE USING THE EQUIPMENT

BUILDER SAS 32, rue Aristide Bergès - ZI 31270 Cugnaux – France MADE IN RPC 2021

# 1. THE PRODUCT

## 1.1 Components



1	frame	5b	Direction switch
2	motor wheel	6	Tray
3	battery box	7	ON-OFF switch
4	handle grip	8	plug for battery charging cable
5	motor control element	9	operation indicator
5a	Right handle cap	10	castors with brake

## 1.2 Delivery content

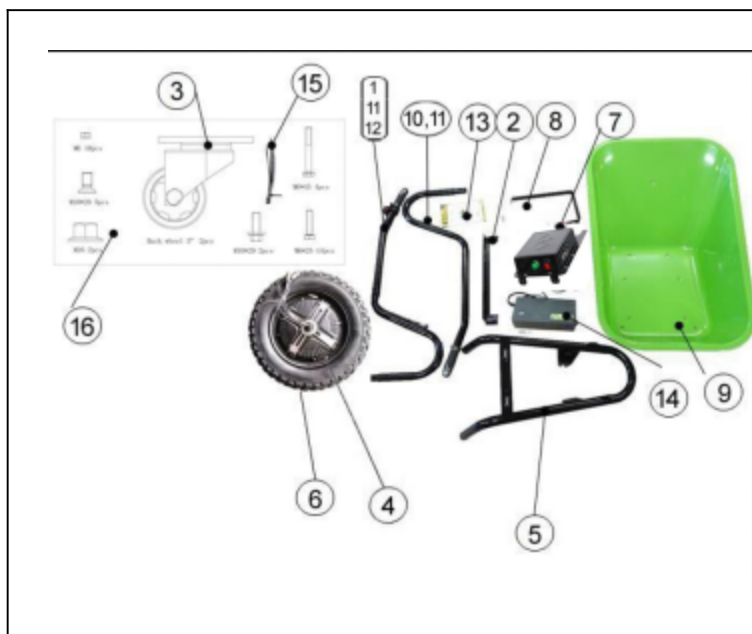

No	Parts name	Qty
1	left Handle	1
2	Reinforce Rib	1
3	castors with brake	2
4	Wheel & Motor Assy	1
5	frame Front	1
6	Tyre	1
7	Batterybox (with motor controller)	1
8	tray Support 2	1
9	Mulde / tray	1
10	left Handle	1
11	Handle Cap	1
12	Motor control	1
13	Manual	1
14	charger	1
15	Cable tie	6
16	Fixation material(as shown)	1

### 1.3 Technical data

Rated voltage	40V d.c.
Battery capacity	6 Ah
Max Battery worktime [h]	5 h
Motor power	500 W
Motor rated speed	100 min <sup>-1</sup>
speed	max. 6,0 km/h
max. load capacity	150kg / 80l
Net weight	27 kg
Dimension	139x65x90cm
<b>Charger:</b>	FBRE40V(C4202); FBRE40V-UK(4202)
Input voltage	220-240V~ 50/60Hz,0.44A
Power	97 W
Out put	42V d.c. 2A
Charge time	3 h
Protection class II	II
<b>Battery:</b>	FBRE40V; FBRE40V-UK
Rated voltage	40 V d.c.
Battery capacity	6 Ah
Battery power	240Wh
Weight	3.7kg
Dimension	370x200x95cm

## 2. SAFETY WARNINGS

### GENERAL POWER TOOL SAFETY WARNINGS

**WARNING** Read all safety warnings, instructions, illustrations and specifications provided with this power tool. Failure to follow all instructions listed below may result in electric shock, fire and/or serious injury.

Save all warnings and instructions for future reference.

The term "power tool" in the warnings refers to your mains-operated (corded) power tool or battery-operated (cordless) power tool.

#### 1) Work area safety

- a) **Keep work area clean and well lit.** Cluttered or dark areas invite accidents.
- b) **Do not operate power tools in explosive atmospheres, such as in the presence of flammable liquids, gases or dust.** Power tools create sparks which may ignite the dust or fumes.
- c) **Keep children and bystanders away while operating a power tool.** Distractions can cause you to lose control.

#### 2) Electrical safety

- a) **Power tool plugs must match the outlet. Never modify the plug in any way. Do not use any adapter plugs with earthed (grounded) power tools.** Unmodified plugs and matching outlets will reduce risk of electric shock.
- b) **Avoid body contact with earthed or grounded surfaces, such as pipes, radiators, ranges and refrigerators.** There is an increased risk of electric shock if your body is earthed or grounded.
- c) **Do not expose power tools to rain or wet conditions.** Water entering a power tool will increase the risk of electric shock.
- d) **Do not abuse the cord. Never use the cord for carrying, pulling or unplugging the power tool. Keep cord away from heat, oil, sharp edges or moving parts.** Damaged or entangled cords increase the risk of electric shock.
- e) **When operating a power tool outdoors, use an extension cord suitable for outdoor use.** Use of a cord suitable for outdoor use reduces the risk of electric shock.
- f) **If operating a power tool in a damp location is unavoidable, use a residual current device (RCD) protected supply.** Use of an RCD reduces the risk of electric shock.

#### 3) Personal safety

- a) **Stay alert, watch what you are doing and use common sense when operating a power tool. Do not use a power tool while you are tired or under the influence of drugs, alcohol or medication.** A moment of inattention while operating power tools may result in serious personal injury.
- b) **Use personal protective equipment. Always wear eye protection.** Protective equipment such as a dust mask, non-skid safety shoes, hard hat or hearing protection used for appropriate conditions will reduce personal injuries.
- c) **Prevent unintentional starting. Ensure the switch is in the off-position before connecting to power source and/or battery pack, picking up or carrying the tool.**

Carrying power tools with your finger on the switch or energising power tools that have the switch on invites accidents.

- d) **Remove any adjusting key or wrench before turning the power tool on.** A wrench or a key left attached to a rotating part of the power tool may result in personal injury.
- e) **Do not overreach. Keep proper footing and balance at all times.** This enables better control of the power tool in unexpected situations.
- f) **Dress properly. Do not wear loose clothing or jewellery. Keep your hair and clothing away from moving parts.** Loose clothes, jewellery or long hair can be caught in moving parts.

g) If devices are provided for the connection of dust extraction and collection facilities, ensure these are connected and properly used. *Use of dust collection can reduce dust-related hazards.*

h) Do not let familiarity gained from frequent use of tools allow you to become complacent and ignore tool safety principles. *A careless action can cause severe injury within a fraction of a second.*

#### 4) Power tool use and care

a) Do not force the power tool. Use the correct power tool for your application. *The correct power tool will do the job better and safer at the rate for which it was designed.*

b) Do not use the power tool if the switch does not turn it on and off. *Any power tool that cannot be controlled with the switch is dangerous and must be repaired.*

c) Disconnect the plug from the power source and/or remove the battery pack, if detachable, from the power tool before making any adjustments, changing accessories, or storing power tools. *Such preventive safety measures reduce the risk of starting the power tool accidentally.*

d) Store idle power tools out of the reach of children and do not allow persons unfamiliar with the power tool or these instructions to operate the power tool.

*Power tools are dangerous in the hands of untrained users.*

e) Maintain power tools and accessories. Check for misalignment or binding of moving parts, breakage of parts and any other condition that may affect the power tool's operation. If damaged, have the power tool repaired before use.

*Many accidents are caused by poorly maintained power tools.*

f) Keep cutting tools sharp and clean. *Properly maintained cutting tools with sharp cutting edges are less likely to bind and are easier to control.*

g) Use the power tool, accessories and tool bits etc. in accordance with these instructions, taking into account the working conditions and the work to be performed. *Use of the power tool for operations different from those intended could result in a hazardous situation.*

h) Keep handles and grasping surfaces dry, clean and free from oil and grease. *Slippery handles and grasping surfaces do not allow for safe handling and control of the tool in unexpected situations.*

#### 5) Battery tool use and care

a) Recharge only with the charger specified by the manufacturer. *A charger that is suitable for one type of battery pack may create a risk of fire when used with another battery pack.*

b) Use power tools only with specifically designated battery packs. *Use of any other battery packs may create a risk of injury and fire.*

c) When battery pack is not in use, keep it away from other metal objects, like paper clips, coins, keys, nails, screws or other small metal objects, that can make a connection from one terminal to another. *Shorting the battery terminals together may cause burns or a fire.*

d) Under abusive conditions, liquid may be ejected from the battery; avoid contact. If contact accidentally occurs, flush with water. If liquid contacts eyes, additionally seek medical help. *Liquid ejected from the battery may cause irritation or burns.*

e) Do not use a battery pack or tool that is damaged or modified. *Damaged or modified batteries may exhibit unpredictable behaviour resulting in fire, explosion or risk of injury.*

f) Do not expose a battery pack or tool to fire or excessive temperature. *Exposure to fire or temperature above 130 °C may cause explosion.*













g) Follow all charging instructions and do not charge the battery pack or tool outside the temperature range specified in the instructions. Charging improperly or at temperatures outside the specified range may damage the battery and increase the risk of fire.

## 6) Service

a) Have your power tool serviced by a qualified repair person using only identical replacement parts. This will ensure that the safety of the power tool is maintained.

b) Never service damaged battery packs. Service of battery packs should only be performed by the manufacturer or authorized service providers.

## Symbols

	Conforms to relevant safety standards
	To reduce the risk of injury, the user must read and understand this manual before using this product.
	Do not dispose of old appliances with domestic rubbish
	Do not spray the tool
	DANGER! Risk of explosion - Do not use the tool in an explosive atmosphere
	Do not smoke do not use the tool near fire
	Wear antiskid footwear protection.
	Class II, double isolation(only for charger)
	Do not expose the charger or the battery to water.
	Do not incinerate the battery or charger.
	Ambient temperature of 40 °C max. (only for the battery)
	Use the battery and charger Indoor use only.
	Recycling

### 3. INTENDED USE

The machine must only be used for its intended purpose! Any other use is deemed to be a case of misuse.

To use the machine properly you must also observe and follow all safety regulations, the assembly instructions, operating and maintenance instructions lay down in this manual.

All people who use and service the machine have to be acquainted with this manual and must be informed about the machine's potential hazards.

The machine is used for:

Transportation of goods within the maximum permissible load capacity.

	<b>WARNING</b>
	<ul style="list-style-type: none"> <li>- The removal or modification of the safety components may result in damage to equipment and serious injury!</li> </ul> <p><b>HIGHEST RISK OF INJURY!</b></p>

#### Ambient conditions

The machine may be operated:

humidity	max. 70%
temperature	+5°C to +40°C (+41°F to +104°F)

The machine, especially the battery; may not be exposed to a temperature of about 80 ° C. Do not store in the blazing sun or a long time in the trunk of a car.

#### Prohibited use:

- ✓ The operation of the machine outside the stated technical limits described in this manual is forbidden.
- ✓ The operation of the machine without provided protective devices is prohibited.
- ✓ The use of the machine not being suitable for the use of the machine and not being certified is forbidden
- ✓ The use of the machine not according with the required dimensions is forbidden.
- ✓ Any manipulation of the machine and parts is forbidden.
- ✓ The use of the machine for any purposes other than described in this user-manual is forbidden.
  - ✓ It is not allowed to leave the immediate work area during the work is being performed.

### 4. SECURITY INSTRUCTIONS

**Missing or non-readable security stickers have to be replaced immediately!**

**The locally applicable laws and regulations may specify the minimum age of the operator and limit the use of this machine!**

To avoid malfunction, machine defects and injuries, read the following security instructions!

#### GENERAL:

**Use the machine only in good enough light to allow a safe operation can be guaranteed.**

**In tiredness, decreased concentration or under the influence of alcohol or drugs, the work on the machine is prohibited!**

**Caution in slippery conditions - slip hazard - risk of injury. When working, robust and non- slip footwear. Slides / stumble / traps are a major cause of serious injury or death.**

**The machine must be operated only by trained persons (knowledge and understanding of this manual), which have no limitations of motor skills compared with conventional workers.**

**Keep the machine in use with both hands**

**Unauthorized persons, especially children and not trained personnel must be kept away from the running machine!**

**If you pass the machine to third, these instructions must be attached to the machine.**

**Before the start, after the failure or shock, be sure to check the device and make sure that it is in good condition**

Take special care when work near swimming pools or garden ponds.  
 Never use the machine when it is raining or in damp, wet areas.  
 Unplug battery before all maintenance and settings!

**CHARGER:**

The charger is designed exclusively to charge the battery of this machine. Charging other batteries is not permitted.

Never use the charger in a damp or wet environment

Disconnect cable connections only by pulling the plug. Pulling on the cable could damage the cable and plug and electrical safety would no longer be guaranteed.

Never use the charger if the cord, plug or the appliance itself is damaged by external influences.

Attach the charger then to the next workshop.

Do not use the unit near heat sources

Do not use extension cord to supply power to the charging station

Do not place metal objects in the area of the charging contacts of the charger. Do not open the charger. In case of failure, contact a specialist workshop.

Use to recharge your battery only with the original charger. Use of other chargers defects may occur or fire hazard.

**BATTERY:**

Improper use or the use of damaged batteries leaking vapors. Run to fresh air and seek medical attention in case of complaints. The vapors can irritate the respiratory tract. **FIRE HAZARD!** Never charge batteries near acids and flammable materials.

Charge the battery only in an ambient temperature between 0 ° C to +40 ° C. Leave to cool down after heavy load.

**EXPLOSIVE!** Protect the battery from heat and fire.

Use the battery only in an ambient temperature between 0 ° C to +45 ° C.

**SHORT CIRCUIT!** For disposal, transport or storage, the battery must (plastic bag, box) or the contacts are packed must be taped.

Never open the battery

**Remaining risk factors**

Despite intended use, certain residual risks remain. Due to the design and construction of the machine, hazardous situations may occur which are identified as follows in these operating instructions:

**DANGER**

A safety instruction designed in this way indicates an imminently hazardous situation which, if not avoided, will result in death or serious injury.

**WARNING**

Such a safety instruction indicates a potentially hazardous situation which, if not avoided, may result in serious injury or even death.



**CAUTION**

A safety instruction designed in this way indicates a potentially hazardous situation which, if not avoided, may result in minor or moderate injury.

**NOTICE**

A safety note designed in this way indicates a potentially dangerous situation which, if not avoided, may result in property damage.

Irrespective of all safety regulations, your common sense and your corresponding technical suitability/training are and will remain the most important safety factor for error-free operation of the machine. **Safe working depends first and foremost on you!**

**5. ASSEMBLY**

Please check the product contents immediately after receipt for any eventual transport damage or missing parts. Claims from transport damage or missing parts must be placed immediately after initial machine receipt and unpacking before putting the machine into operation. Please understand that later claims cannot be accepted anymore.

**Assembly-steps**

<p><b>Step 1</b></p> <p>W445 2pcs W42 2pcs</p>	<p><b>Step 2</b></p> <p>W445 2pcs W6 2pcs</p>
<p><b>Step 3</b></p>	<p><b>Step 4</b></p>
<p><b>Step 5</b></p> <p>back wheel 1 2pcs W425 8pcs W6 8pcs</p>	<p><b>Step 6</b></p> <p>M18 2pcs</p>
<p><b>Step 7</b></p> <p>M125 4pcs W6 2pcs</p>	<p><b>Step 8</b></p> <p>M125 4pcs</p>

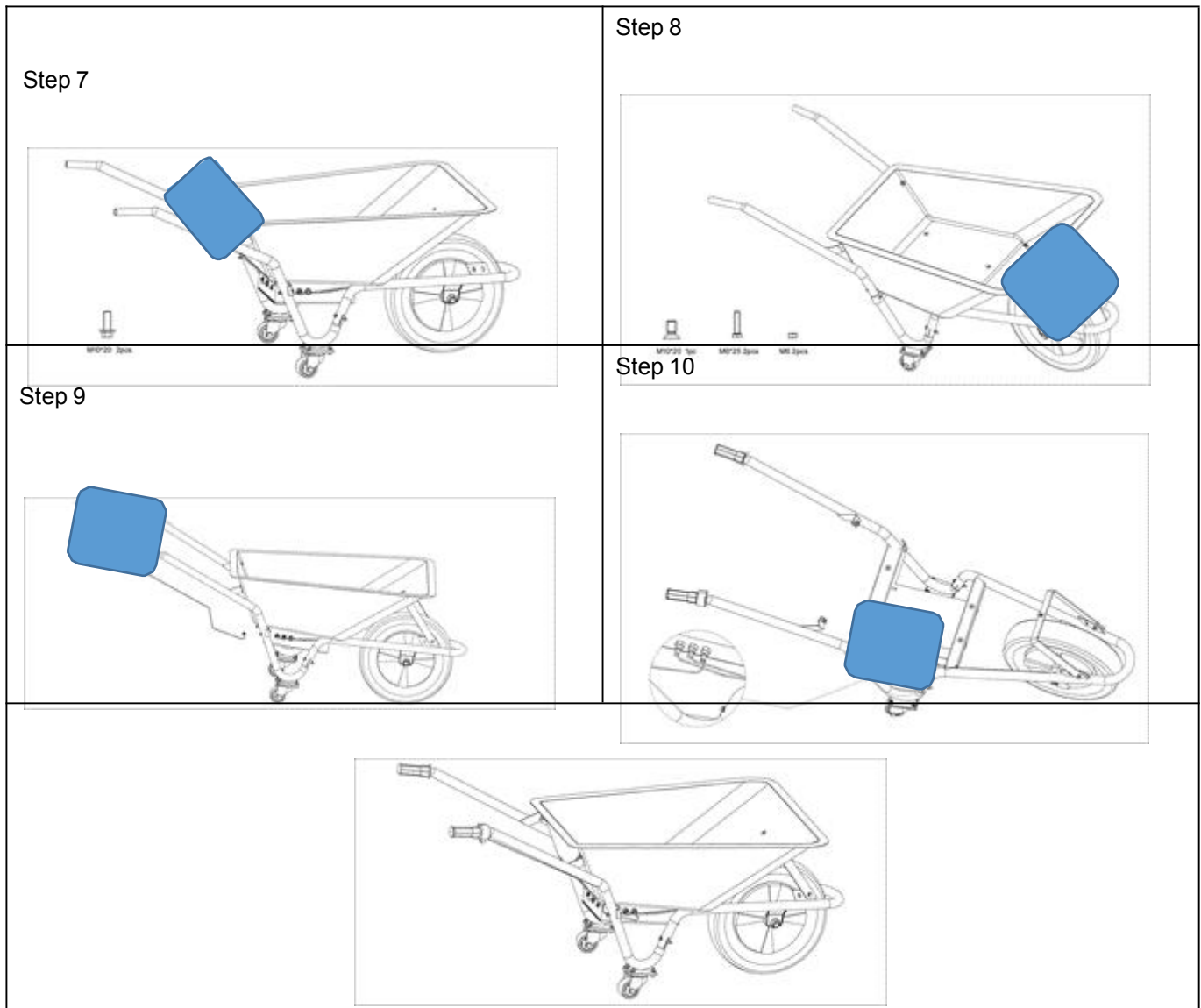

## 6. OPERATION

Device to be operated in a perfect state only. Inspect the device visually every time it is to be used. Check in particular the safety equipment, electrical controls, electric cables and screwed connection for damage and if tightened properly. Replace any damaged parts before operating the device.

### Operation instructions



#### WARNING



Unplug battery before all maintenance and settings!



#### NOTICE

- ✓ Never remove the battery while the machine is running In case of longer standstill, press the shut-down button Use the electric motor only with sufficient battery charge

**Start electrical support**

	<p>1. Press the red power switch to "1" position</p>
	<p>2. Turn the right handle cap anti-clock wisely, the more turn, the bigger power                  Direction switch "0" = go forward                  Direction switch "1" = go backwards                  When power switch ="1" and not turn the handle cap, the BAS will brake the wheelbarrow automatically.</p>

**Charger**

Charger is integrated in the battery box system.

**Charging the battery:**

- 1). Connect the charger to the power supply (AC outlet) 220-240V~ 50/60Hz and the charger plug.
- 2). Charge the battery
- 3). Once the battery is fully charged (indication on the charger) the charger can be removed.

**LED- indication on the control element:**

	<p>Voltage display is on when the red battery switch is on "1" position.</p> <p>When machine is activated by turning the lever following battery capacity is indicated:</p> <ul style="list-style-type: none"> <li>- 42 means- 100% capacity</li> <li>- 37 means- 50 capacity left</li> <li>- &lt;30 please recharge the battery</li> </ul>
-------------------------------------------------------------------------------------	---------------------------------------------------------------------------------------------------------------------------------------------------------------------------------------------------------------------------------------------------------------------------------------------------------------------------------------------

**7. MAINTENANCE**

	<p><b>ATTENTION</b></p>
<p><b>Unplug battery before all maintenance and settings!</b>  <b>Serious injury due to unintentional or automatic activation of the machine!</b></p>	

The machine does not require extensive maintenance. If malfunctions and defects occur, let it be serviced by trained persons only.

<p><b>NOTICE</b></p>
<p>Clean your machine regularly after every usage – it prolongs the machines lifespan and is a pre- requisite for a safe working environment.</p> <p><b>Repair jobs shall be performed by respectively trained professionals only!</b></p>

Check regularly the condition of the security stickers. Replace them if required. Check regularly the condition of the machine.

Store the machine in a closed, dry location

## Maintenance plan

After each workshift: Check the cables (tight fit, damage)

## 8. CLEANING

### NOTICE

**The usage of certain solutions containing ingredients damaging metal surfaces as well as the use of scrubbing agents will damage the machine surface!**

Clean the machine surface with a wet cloth soaked in a mild solution

**Never use running water or a high pressure cleaner to clean the machine.**

Clean the outer parts with a damp sponge.

Never clean the electronic parts with water!

Check the machine and remove the deposits and / or residues with a brush

## 9. STORAGE

- Clean thoroughly all components before storage.
  - Store all components separately in a dry area at not less than -10 ° C.
- Charge the battery fully before storing.

### NOTICE

During longer standstill but at least after one month charge the battery.

## 10. DISPOSAL



Do not dispose the machine and the battery in residual waste. Contact your local authorities for information regarding the available disposal options. When you buy at your local dealer for a replacement unit, the latter is obliged to exchange your old.

## 11. TROUBLE SHOOTING

**BEFORE YOU START WORKING FOR THE ELIMINATION OF DEFECTS, UNPLUG THE BATTERY.**

Trouble	Possible cause	Solution
<b>No electrical support</b>	· Battery is not charged	· Recharge battery
	· Motor stuck	· Check motor
	· Power switch is damaged	· Check switch
	· Broken or loose cables	· Check cables
<b>No charging of battery</b>	· Loosen cable	· Check cable connection

## 12. SPARE PARTS

**The installation of other than original spare parts voids the warranty!** So you always have to use original spare parts

When you place a spare parts order please use the service formular you can find in the last chapter of this manual. Always take a note of the machine type, spare parts number and partname. We recommend to copy the spare parts diagram and mark the spare part you need.

[You find the order address in the preface of this operation manual.](#)

### Exploded view

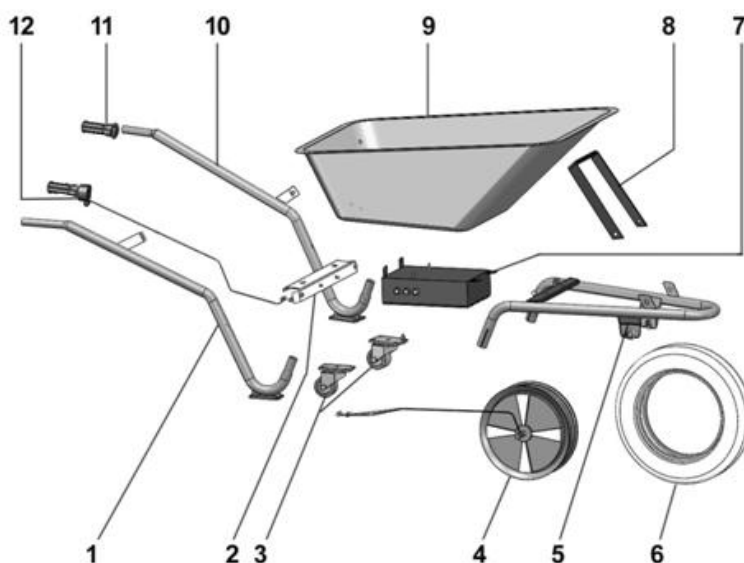

Pos	Parts name	Qty
1	left Handle	1
2	Reinforce Rib	1
3	castors with brake	2
4	Wheel & Motor Assy	1
5	frame Front	1
6	Tyre	1
7	Battery box (with motor controller)	1
8	tray Support 2	1
9	Mulde / tray	1
10	left Handle	1
11	Left Handle Cap	1
12	Right handle with motor control	1

## 13. DECLARATION OF CONFORMITE

---



BUILDER SAS  
32 rue Aristide Berges -Z1 31270 Cugnaux - France  
Tel: +33 (0) 5.34.508.508 Fax: +33 (0) 5.34.508.509

Declare that the machine designated below

ELECTRICAL WHEEL BARROW

FBRE40V & FBRE40V-UK

[S/N: 20210170736-20210170775/20210170776-20210170815/20210454287-20210454672](#)

Conforms to the provisions of the Machinery Directive 2006/42 / EC and the national regulations transposing it;

Also complies with the provisions of the following European directives:

EMC Directive 2014/30 / EU

ROHS Directive: 2011/65 / EU

Also complies with European standards, national standards and the following technical provisions:

EN ISO 12100:2010

**EN 62841-1:2015**

EN60204-1:2006+A1:2009+AC:2010

EN 55032:2015+AC:2016

EN 55035:2017

EN 61000-3-2:2014

EN 61000-3-3:20113

**EN62133:2013, EN 61000-6-1:2007, EN 61000-6-3:2007+A1:2011+AC:2012**

**EN62368-1 :2014+A11 :2017**

Cugnaux, 10/03/2021

A handwritten signature in black ink, appearing to read 'Philippe MARIE', enclosed in a light blue rectangular box.

Philippe MARIE / PDG

Technical file manager : Julia Zou

# 14. WARRANTY



## WARRANTY

The manufacturer guarantees the product against defects in material and workmanship for a period of 2 years from the date of the original purchase. The warranty only applies if the product is for household use. The warranty does not cover breakdowns due to normal wear and tear.

The manufacturer agrees to replace parts identified as defective by the designated distributor. The manufacturer does not accept responsibility for the replacement of the machine, in whole or in part, and/or ensuing damage.

### The warranty does not cover breakdowns due to:

- insufficient maintenance.
- abnormal assembly, adjustment or operations of the product.
- parts subject to normal wear and tear.

### The warranty does not extend to:

- shipping and packaging costs.
- using the tool for a purpose other than that for which it was designed.
- the use and maintenance of the machine done in a manner not described in the user manual.

Due to our policy of continuous product improvement, we reserve the right to alter or change specifications without notice. Consequently, the product may be different from the information contained therein, but a modification will be undertaken without notice if it is recognized as an improvement of the preceding characteristic.

### READ THE MANUAL CAREFULLY BEFORE USING THE MACHINE.

When ordering spare parts, please indicate the part number or code, you can find this in the spare parts list in this manual. Keep the purchase receipt; without it, the warranty is invalid. To help you with your product, we invite you to contact us by phone or via our website:

- **+33 (0)9.70.75.30.30**
- **<https://services.swap-europe.com/contact>**

You must create a "ticket" via the web platform.

- Register or create your account.
- Indicate the reference of the tool.
- Choose the subject of your request.
- Describe your problem.
- Attach these files: invoice or sales receipt, photo of the identification plate (serial number), photo of the part you need (for example: pins on the transformer plug which are broken).



# 15. PRODUCT FAILURE

## WHAT TO DO IF MY MACHINE BREAKS DOWN?

### If you bought your product in a store:

a) Empty the fuel tank.

b) Make sure that your machine is complete with all accessories supplied, and clean! If this is not the case, the repairer will refuse the machine.

Go to the store with the complete machine and with the receipt or invoice.

### If you bought your product on a website:

a) Empty the fuel tank.

b) Make sure that your machine is complete with all accessories supplied, and clean! If this is not the case, the repairer will refuse the machine.

c) Create a SWAP-Europe service ticket on the site: <https://services.swap-europe.com> When making the request on SWAP-Europe, you must attach the invoice and the photo of the nameplate (serial number).

d) Contact the repair station to make sure it is available before dropping off the machine.

Go to the repair station with the complete machine packed, accompanied by the purchase invoice and the station support sheet downloadable after the service request is completed on the SWAP-Europe site

For machines with engine failure from manufacturers BRIGGS & STRATTON, HONDA and RATO, please refer to the following instructions.

Repairs will be done by approved engine manufacturers of these manufacturers, see their site:

- <http://www.briggsandstratton.com/eu/fr>
- <http://www.honda-engines-eu.com/fr/service-network-page;jsessionid=5EE8456CF39CD572AA2AEEDFD290CDAE>
- <https://www.rato-europe.com/it/service-network>

**Please keep your original packaging to allow for after-sales service returns or pack your machine with a similar cardboard box of the same dimensions.**

**For any question concerning our after-sales service you can make a request on our website <https://services.swap-europe.com>**

**Our hotline remains available at +33 (9) 70 75 30 30.**





# 16. WARRANTY EXCLUSIONS

## THE WARRANTY DOES NOT COVER:

- Start-up and setting up of the product.
- Damage resulting from normal wear and tear of the product.
- Damage resulting from improper use of the product.
- Damage resulting from assembly or start-up not in accordance with the user manual.
- Breakdowns related to carburetion beyond 90 days and fouling of carburetors.
- Periodic and standard maintenance events.
- Actions of modification and dismantling that directly void the warranty.
- Products whose original authentication marking (brand, serial number) has been degraded, altered or withdrawn.
- Replacement of consumables.
- The use of non-original parts.
- Breakage of parts following impacts or projections.
- Accessories breakdowns.
- Defects and their consequences linked to any external cause.
- Loss of components and loss due to insufficient screwing.
- Cutting components and any damage related to the loosening of parts.
- Overload or overheating.
- Poor power supply quality: faulty voltage, voltage error, etc.
- Damages resulting from the deprivation of enjoyment of the product during the time necessary for repairs and more generally the costs related to the immobilization of the product.
- The costs of a second opinion established by a third party following an estimate by a SWAP-Europe repair station
- The use of a product which would show a defect or a breakage which was not the subject of an immediate report and/or repair with the services of SWAP-Europe.
- Deterioration linked to transport and storage\*.
- Launchers beyond 90 days.
- Oil, petrol, grease.
- Damages related to the use of non-compliant fuels or lubricants.

\* In accordance with transport legislation, damage related to transport must be declared to carriers within 48 hours maximum after observation by registered letter with acknowledgement of receipt.

This document is a supplement to your notice, a non-exhaustive list.

**Attention:** all orders must be checked in the presence of the delivery person. In case of refusal by the delivery person, it you must simply refuse the delivery and notify your refusal.

**Reminder:** the reserves do not exclude the notification by registered letter with acknowledgement within 72 hours.

### Information:

Thermal devices must be wintered each season (service available on the SWAP-Europe site). Batteries must be charged before being stored.